

High fronted pull-out – C



Web code – click on the code or enter it in the Product Configurator

DQBQ2M

Planning

Space requirement in cabinet

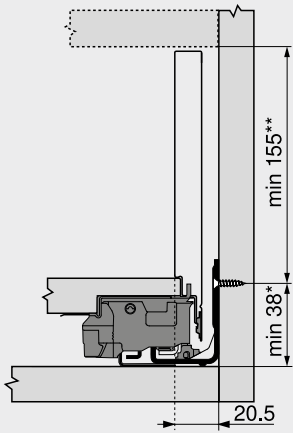

* +1 mm if cabinet profile is installed before the cabinet is assembled
 ** Incl. 2 mm tilt adjustment

Installation dimensions – front – screw-on

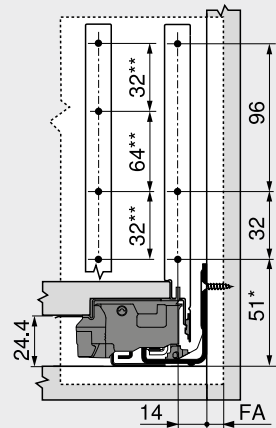

FA Front overlay
 * +1 mm if cabinet profile is installed before the cabinet is assembled
 ** Alternative 4a

Drilling distances – front – EXPANDO | EXPANDO T

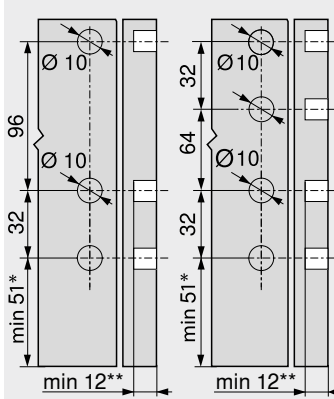

4 4a
 * +1 mm if cabinet profile is installed before the cabinet is assembled
 ** Min. 6 mm for EXPANDO T

Installation dimensions – back

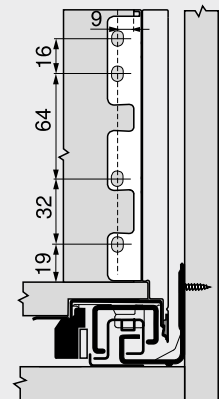

Cutting – 16 mm chipboard

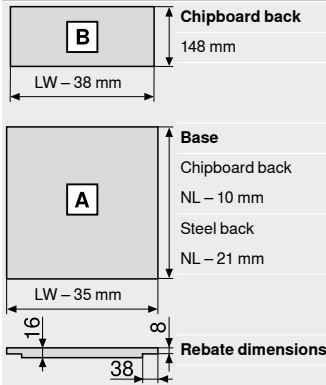

LW Internal cabinet width
 NL Nominal length

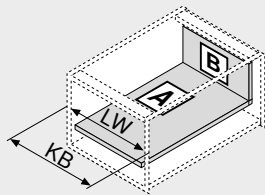

LW Internal cabinet width
 KB Cabinet width

Drilling distances – base

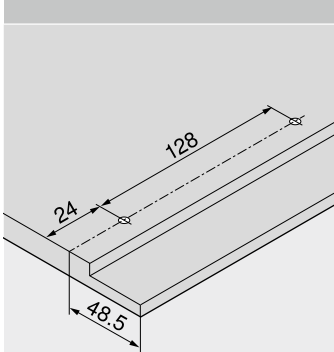

Reference pages

Overview	197	TIP-ON BLUMOTION for LEGRABOX MERIVOBOX TANDEMBOX	394	Blum services	602
myLEGRABOX	236			More technical details	708
Fixing system for thin fronts – EXPANDO T	596	TIP-ON for LEGRABOX	404	Assembly, removal and adjustment	
Assembly recommendation and limitation of liability – EXPANDO T	597			AMBIA-LINE for LEGRABOX MERIVOBOX	542
SERVO-DRIVE for LEGRABOX MERIVOBOX TANDEMBOX	362	CABLOXX	594		
		Accessories	244		
		Cabinet profile fixing positions	248		
				Short URL	www.blum.com/a310

